

For more detailed installation, configuration, programming, file transfer, and operating instructions, refer to the *VG-Series Modero Touch Panels Instruction Manual* available on-line at www.amx.com.



FIG. 1 Wall Mount and Table Top 1500VG Touch Panels

ATTENTION!

Verify you are using the latest NetLinX Master and Modero touch panel firmware (available from www.amx.com). Verify the TPDesign4 program being used is **Version 2.6** or higher.

Overview

The VG-Series of touch panels can be fitted for either Video (Composite) or RGB (Component) via the use of two kit configurations: Video Kit and RGB Kit. Each kit comes with its own group of standard components that are specific to its configuration. The following table outlines the different configurations available for 1500VG panels:

Modero 1500VG Multimedia Touch Panels	
With Video Kit	
NXD-1500VG (FG2253-61V)	15" Modero Multimedia WallMount Panel with Video Kit.
NXT-1500VG (FG2252-61V)	15" Modero Multimedia Table Top Panel with Video Kit.
With RGB Kit	
NXD-1500VG (FG2253-61RGB)	15" Modero Multimedia WallMount Panel with RGB Kit.
NXT-1500VG (FG2252-61RGB)	15" Modero Multimedia Table Top Panel with RGB Kit.

Specifications

1500VG Specifications	
Dimensions (HWD):	<ul style="list-style-type: none"> NXD-1500VG (with faceplate): 14.37" x 15.20" x 3.31" (36.50 cm x 38.61 cm x 8.40 cm) NXT-1500VG (Fully raised): 12.94" x 14.95" x 11.73" (32.87 cm x 37.97 cm x 29.78 cm) NXT-1500VG (Fully lowered): 7.45" x 14.95" x 11.72" (18.92 cm x 37.97 cm x 29.77 cm) CB-TP15 (conduit/wallbox): 13.48" x 14.18" x 3.49" (34.24 cm x 36.00 cm x 8.85 cm) MB-TP15 (VESA mounting box): 14.37" x 15.19" x 3.59" (36.50 cm x 38.59 cm x 9.12 cm)
Power:	<ul style="list-style-type: none"> Constant current draw: 3.7 A @ 12 VDC (stand-alone) Startup current draw: 5.5 A @ 12 VDC (stand-alone)
Minimum power supply required:	<ul style="list-style-type: none"> PSN6.5 Power Supply (FG423-41) - using accessories can increase the power draw requirements
Memory:	<ul style="list-style-type: none"> 256 MB on-board memory 128 MB Compact Flash (upgradeable to 1 GB factory programmed)
Weight:	<ul style="list-style-type: none"> NXD-1500VG: 13.45 lbs (6.10 kg) NXT-1500VG: 17.15 lbs (7.78 kg)
LCD Parameters:	<ul style="list-style-type: none"> Aspect Ratio: 4:3 Brightness (luminance): 400 cd/m2 Channel transparency: 8-bit Alpha channel transparency Contrast ratio: 300:1 Display area (HW): 304.13 mm x 228.10 mm Display colors: 16 million colors (24-bit color depth) Dot/pixel pitch: 0.297 mm Screen resolution (HW): 1024 x 768 Video formats: NTSC, PAL, and SECAM (shown within variable-size video windows)
Viewing Angles:	<ul style="list-style-type: none"> Vertical: + 85° (up from center) and - 85° (down from center)
Supported Audio Sample Rates:	<ul style="list-style-type: none"> 48000Hz, 44100Hz, 32000Hz, 24000Hz, 22050Hz, 16000Hz, 12000Hz, 11025Hz, and 8000Hz.
Certifications:	<ul style="list-style-type: none"> FCC Part 15 Class B, CE, and EN 60950

1500VG Specifications (Cont.)	
Supported Transport Protocols:	<ul style="list-style-type: none"> RTP (MPEG-2/MPEG-4 Transport Stream) UDP (MPEG-2 Transport Stream)
Supported Audio Codecs:	<ul style="list-style-type: none"> Advanced Audio Coding (AAC) MPEG Audio Level 2 (MP2) MPEG Audio Level 3 (MP3)
Supported Video Codecs:	<ul style="list-style-type: none"> MPEG-2 MPEG-4
Front Panel Components:	<ul style="list-style-type: none"> Light Sensor: Photosensitive light detector for automatic adjustment of the panel brightness Motion Sensor (PIR): Proximity Infrared Detector to wake the panel when panel is approached Front Setup Access Button: Pushbutton (grey) used to either put the panel into a "sleep" or "wake" state Microphone: Used for intercom applications Speakers: Stereo output with a frequency response of 450 Hz - 7 KHz
Rear Panel Components:	<ul style="list-style-type: none"> RGB Connector: Made available only by using an NXA-RGB interface card installed within the touch panel. Used with Component/RGB signals Audio/Video Connector: RJ-45 connector for communication of differential audio/video signals Ethernet 10/100 Port: RJ-45 port for 10/100 Mbps communication PWR Connector: 2-pin 3.5 mm mini-Phoenix connector Stereo Output Connector: Stereo output through a 3.5mm mini-jack USB Connector: Two Type A USB ports Mini-USB Connector: 5-pin Mini-USB connector
Operating / Storage Environments:	<ul style="list-style-type: none"> Operating Temperature: 10° C (50° F) to 40° C (104° F) Operating Humidity: 20% to 85% RH Storage Temperature: -20° C (-4° F) to 60° C (140° F) Storage Humidity: 5% to 85% RH
Included Accessories:	<ul style="list-style-type: none"> Installation Kit for 15" NXD panels (KA2251-02): <ul style="list-style-type: none"> 2-pin mini-Phoenix connector (41-5025) Four Drywall clips (62-5924-05) and #6 -metal strips (80-0192) Three Phillips-head screws (#4-20 x 0.250 Black) (80-0114-08) Two CAT5 Suppression Ferrites (04-0014) Installation Kit for 15" and 17" NXT panels (KA2251-04): <ul style="list-style-type: none"> 2-pin mini-Phoenix connector (41-5025) One CAT5 Suppression Ferrites (04-0014) Three Phillips-head screws (#4-20 x 0.250 Black) (80-0114-08) Included within the RGB Kit (FGxxxx-xxRGB) is the following: <ul style="list-style-type: none"> Modero VG Touch Panel (NXD/NXT-1200/1500/1700VG) NXA-AVB/RGB Breakout Box (FG2254-11) NXA-RGB internal RGB/VGA Interface Card (FG2260) NXA-RGBCBL, 15-pin to 5X BNC RGB Breakout cable (FG2250-80) NXA-MTC/RGB Modero 10' foot Table Top Cable (with RGB connector) (CA2250-70) Included within the Video Kit (FGxxxx-xV) is the following: <ul style="list-style-type: none"> Modero VG Touch Panel (NXD/NXT-1200/1500/1700VG) Modero 10' foot Table Top Cable (CA2250-50) NXA-AVB/ETHERNET Breakout Box (FG2254-10)
Other AMX Equipment:	<ul style="list-style-type: none"> CB-TP15 Conduit/Wallbox (FG032-10) CC-USB (Type A) to Mini-B 5-Wire programming cable (FG10-5965) Kensington Lock Bracket (FG2259-10) (optional only with NXTs) MAX-CSE MAX Video Encoder (FG2178-70) MB-TP15 Universal VESA Mounting Box (FG032-50) NXA-AVB/ETHERNET Breakout Box (FG2254-10) NXA-AVB/RGB Breakout Box (FG2254-11) NXA-BASE/B (FG2255) NXA-MTC/RGB Modero 10' foot Table Top Cable (with RGB connector) (CA2250-70). This cable is not wall-rated for NXD models. NXA-PCI80211G Wireless Card (FG2255-04) NXA-RGBKIT RGB upgrade kit for Composite Video touch panels (FG2255-11): <ul style="list-style-type: none"> NXA-AVB/RGB Breakout Box (FG2254-11) NXA-MTC/RGB Modero 10' foot Table Top Cable (with RGB connector) (CA2250-70) NXA-RGB internal RGB/VGA Interface Card (FG2260) NXA-RGBCBL, 15-pin to 5X BNC RGB Breakout cable (FG2250-80) NXT Table Top replacement I/O plate (with RGB connector opening) (62-2250-59) NXD WallMount replacement adhesive overlay for existing I/O plate (53-2250-03) <p>Note: The NXT replacement I/O plate is a single piece which is meant to be swapped-out with the pre-existing plate shipped with Composite Video panels. On NXD panels, the RGB connector opening is pre-drilled into the I/O plate but can only be accessed by replacing the adhesive cover and maintaining the existing overlay. When upgrading NXD panels with this kit, don't replace the NXD I/O plate, only the adhesive cover.</p> <ul style="list-style-type: none"> NXA-RGBCBL, 15-pin to 5X BNC RGB Breakout cable (FG2250-80) NXA-RK15 Rackmount kit for 15" Wall Mount panels (FG2904-51) NXT-BP (FG2250-10) NXT-CHG (FG2250-50) PSN6.5 Power Supply (12 VDC) (FG423-41) Upgrade Compact Flash (factory programmed with firmware): <ul style="list-style-type: none"> NXA-CFTPV256M - 256 MB V/VG compact flash card (FG2116-43) NXA-CFTPV512M - 512 MB V/VG compact flash card (FG2116-44) NXA-CFTPV1G - 1 GB V/VG compact flash card (FG2116-45)

Panel Connectors

FIG. 2 shows the connectors located on the 1500VG Modero Multimedia touch panels.

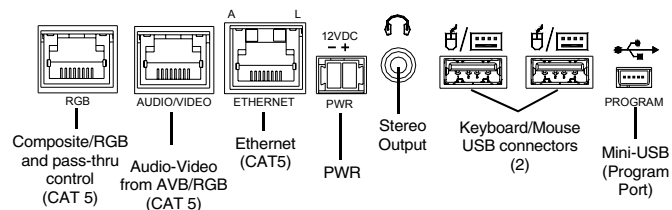

FIG. 2 Connector layout on the 1500VG Touch Panels

NXA-AVB/RGB Breakout Box

FIG. 3 shows the front and rear connectors on the NXA-AVB/RGB breakout box. This breakout box can be mounted on either a horizontal flat surface or into an equipment rack (using an optional AC-RK Rack Kit).

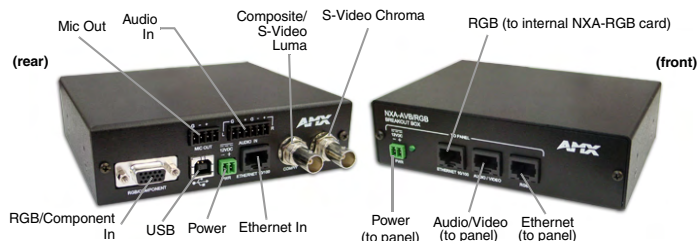

FIG. 3 Connector layouts on the NXA-AVB/RGB Breakout Box

Wiring the NXA-AVB/RGB Connectors and Cables

The inputs and outputs on the breakout box are separated into front and rear connectors. The rear connectors are used to input external signals. The front connectors are used to communicate signals between the NXA-AVB/RGB and a target Modero panel. FIG. 4 provides a layout of the wiring connections on both sides of the breakout box. **Power should be applied to the NXA-AVB/RGB only after all connections have been secured onto both the breakout box and the target panel.**

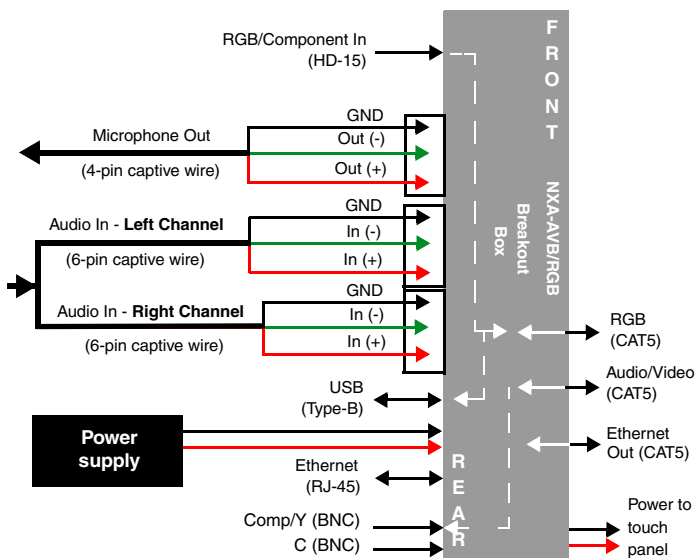

FIG. 4 NXA-AVB/RGB Breakout Box connector wiring diagram

Use the NXA-MTC/RGB cable to provide both communication and 10/100 network connectivity between the target panel, NXA-AVB/RGB, NetLinx Master, and the network.

The RJ-45 connector is used to route the signals connected to the RGB / Component input port on the rear of the AVB/RGB Breakout Box to the VG-Series Modero panel. Standard CAT5 cable can be used for this connection with short cable runs under 50 feet (15.24 m). For cable runs over 50 feet (15.24 m), AMX recommends using the Belden Brilliance VideoTwist 7987. This Belden cable is not CAT5 compliant, but is designed to control skew

between the red, green, and blue video signals. Therefore, for longer cable runs, the video quality will be much higher using the Belden VideoTwist 7987 cable versus standard CAT5 (or other Ethernet compliant cables).

Wiring for Unbalanced Audio

Use FIG. 5 to configure an unbalanced audio connection.

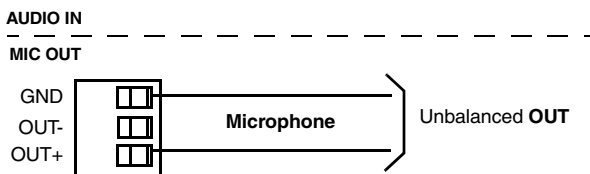
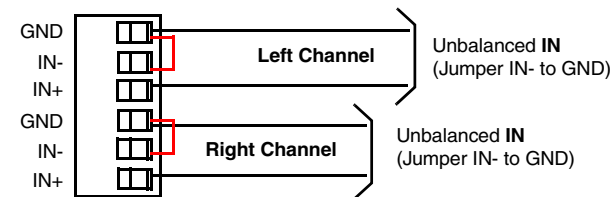

FIG. 5 Wiring the rear AUDIO IN and MIC OUT for use with Unbalanced Audio

Wiring for Balanced Audio

Use FIG. 6 to configure a balanced audio connection.

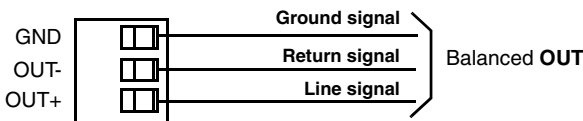

FIG. 6 Wiring the rear AUDIO IN and MIC OUT for use with Balanced Audio

Modero Setup and System Connection

- Carefully remove the panel from the shipping box, peel the protective plastic cover from the LCD and apply power to the panel.
- From below the LCD, press the grey Front Setup Access button for 6 seconds (passing-over the Setup page) to access the Calibration setup page and follow the on-screen instructions.
- Press the grey Firmware Setup Access button for 3 seconds to open the Setup page and touch the on-screen **Protected Setup** button.
- Enter the panel password into the keypad. Factory default is **1988**.
- Press the *Device Number* field to open the on-screen Device Number keypad and enter a value for the panel (*default is 10001*).
- Press **Done** when finished and press the on-screen **Reboot** button to cycle power to the panel.
- Repeat step 3 to access the Protected Setup page and touch the **System Settings** button to open the System Settings page (FIG. 7).

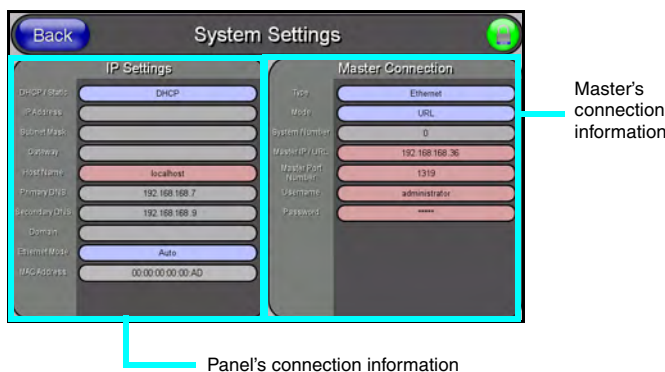

FIG. 7 Sample System Settings page

- Toggle the *Type* field to **Ethernet** and enter both the System Number and IP Address of the target Master.
- Enter a valid Username and/or Password (*if the target Master is secured*).
- Press the **Back** button and then press the on-screen **Reboot** button to save the changes and cycle power.

For full warranty information, refer to the AMX Instruction Manual(s) associated with your Product(s).

11/07

©2007 AMX. All rights reserved. AMX and the AMX logo are registered trademarks of AMX.

AMX reserves the right to alter specifications without notice at any time.

3000 RESEARCH DRIVE, RICHARDSON, TX 75082 • 800.222.0193 • fax 469.624.7153 • technical support 800.932.6993 • www.amx.com

93-2252-61 REV: H

